

PRODUCT SPECIFICATIONS

Product	Slimline Tile Insert 26 (STI26)
Code	STI26-S-1, STI26-M-1, STI26-G-1, STI26-BN-1
Colours Available	Silver, Midnight, Gold, Brushed Nickel
Length	1000mm
Width	100mm
Depth	26mm
Material	Anodised Aluminium
Weight	1.6kg
Applications	Indoor and Outdoor
Features	<ul style="list-style-type: none"> • No visible holes • Suitable for tiles up to 11mm thick • Easy roll out feature for cleaning and maintenance • Anti-water tracking design • Lifetime Rustproof Warranty • UV Stable
Scope of Use	DN 90 40mm, 50mm, 72mm, 80mm
Load Rating	Class B - Maximum Load at 10.2 tons

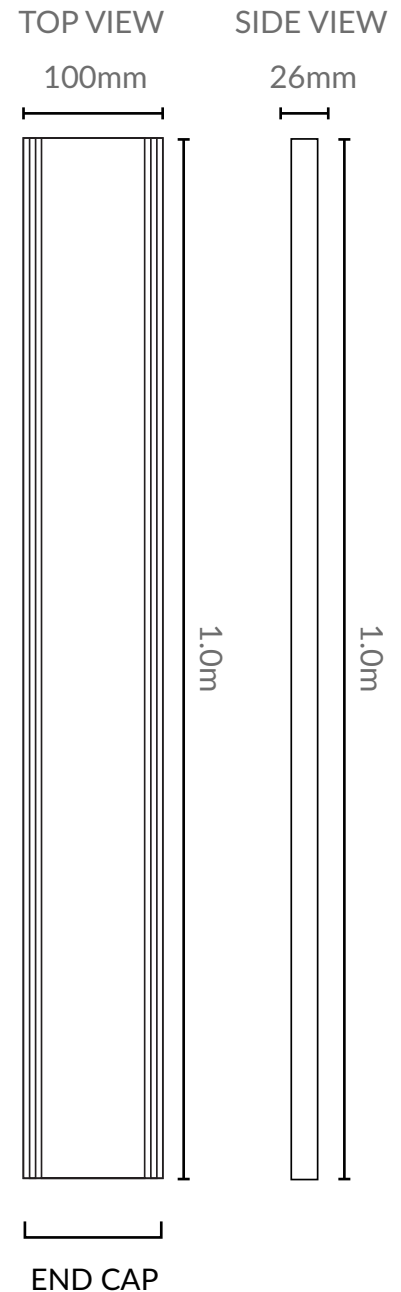

* Regular, gentle cleaning with soapy water is recommended. Do not use abrasive cloths or acidic chemicals on the grates.

CUTTING INSTRUCTIONS AND INSTALLATION

For ease of cutting Lauxes grates, we recommend using a compound mitre saw fitted with a multi-material cutting blade 80 tooth or more. We also recommend using a Lauxes TCT hole saw to drill the hole for the waste outlet.

1. Cut the bottom tray 3mm shorter than desired length to allow end caps to be fitted.
2. Cut the top grate 1mm shorter than the bottom tray to allow for easy roll-in of top grate and tidy fit.
3. Using a suitable size Lauxes hole saw for your pop waste, drill out the hole at the required position to align with the waste pipe in the floor.
4. Insert the end caps into bottom tray and secure with a bead of silicone on the outside of tray.
5. Place silicone around the lip of the pop waste and secure to the underside of bottom tray at the recently drilled hole.

* During installation use a template to ensure the grate does not come in contact with any wet cement based products.

* When installing tile, use a neutral cure silicone.

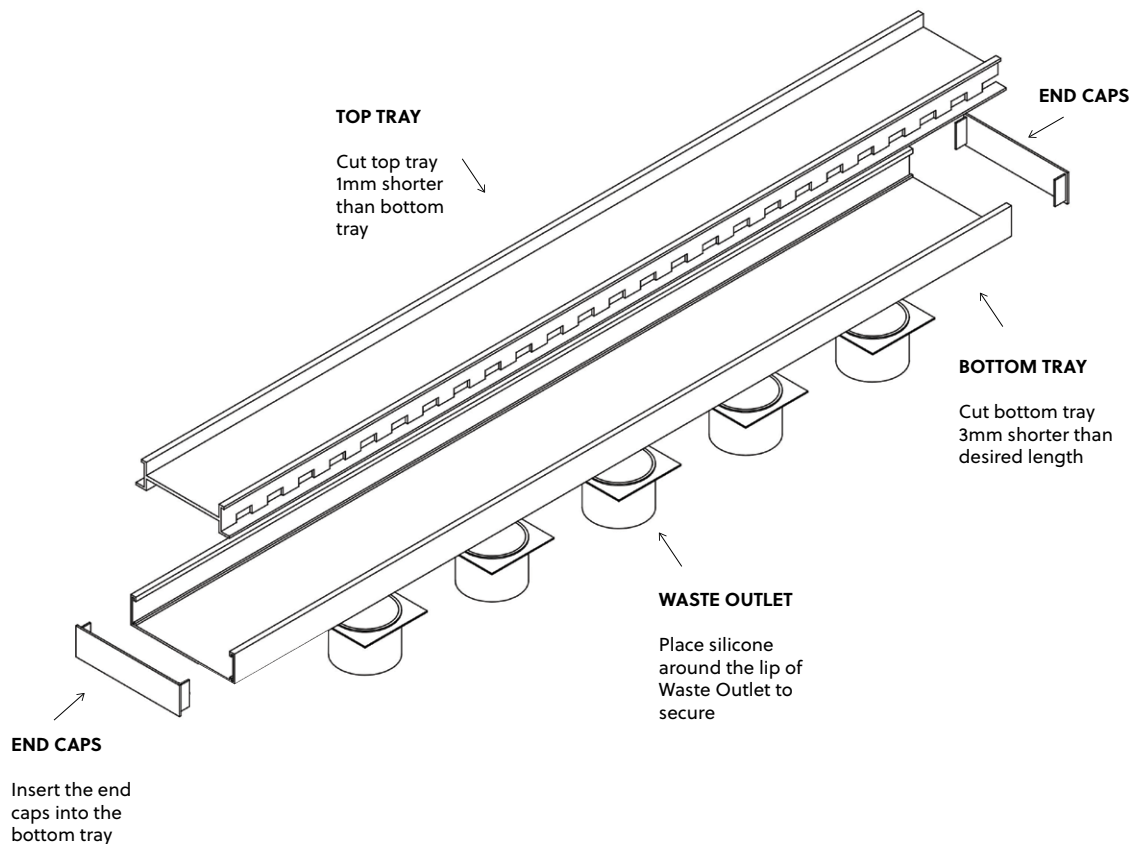

Installation to be by a licensed plumber and in accordance with AS/NZS 3500.2.

Disclaimer: All Lauxes grates and accessories hold WaterMark Certification in accordance with WMTS - 040.